

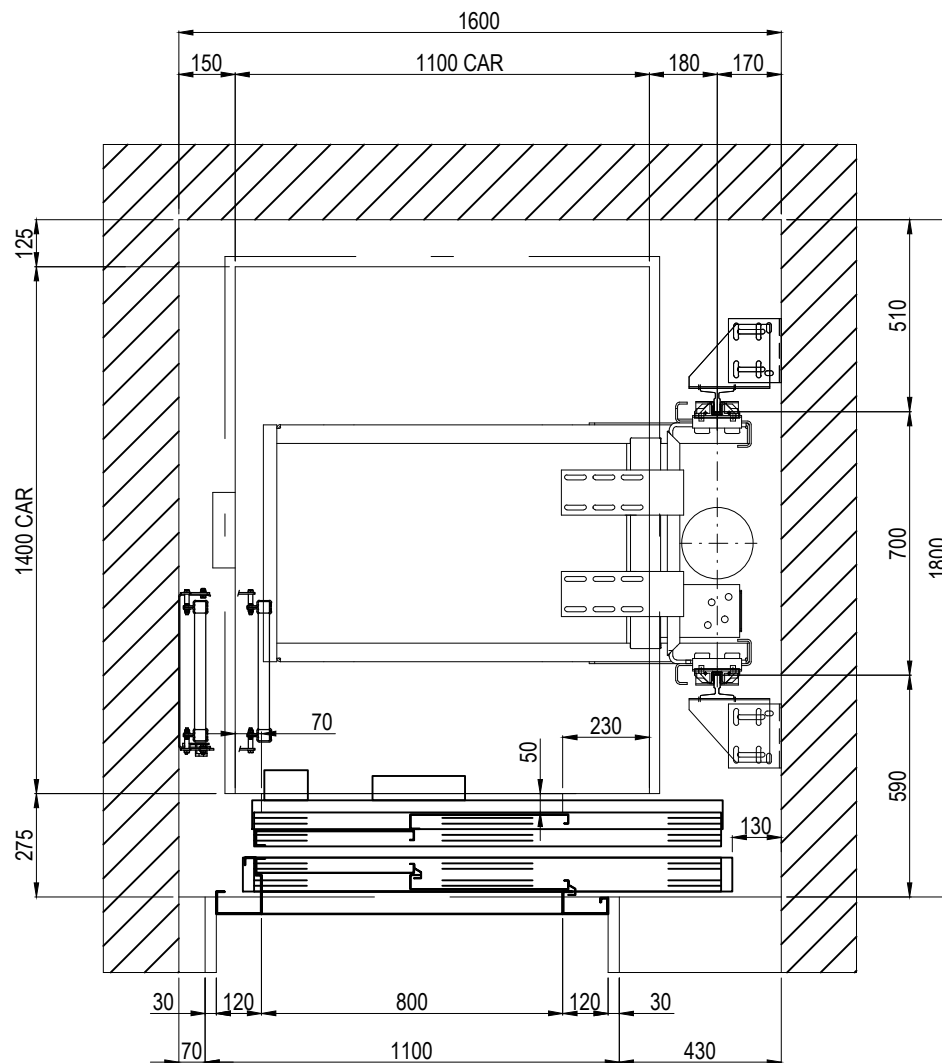

An independent family business since 1867

8 Person (630kg) 2S 800 Doors Hydraulic Machine Room

Stannah



Waiver:

This data sheet is for guidance only and must not be used for proper working drawings. Please contact Stannah Lifts for particular details before proceeding. Owing to our policy of continual improvement we reserve the right to alter specifications and dimensions without prior notice

APPROVED 19/02/15

Stannah Lifts Ltd.
Anton Mill, Andover, Hampshire. SP10 2NX
Tel: 01264 339090
www.stannahlifts.co.uk



An independent family business since 1867

Maxilift 2.0

8 Person (630kg)

2S 800 Doors Through Car Hydraulic Machine Room

Stannah

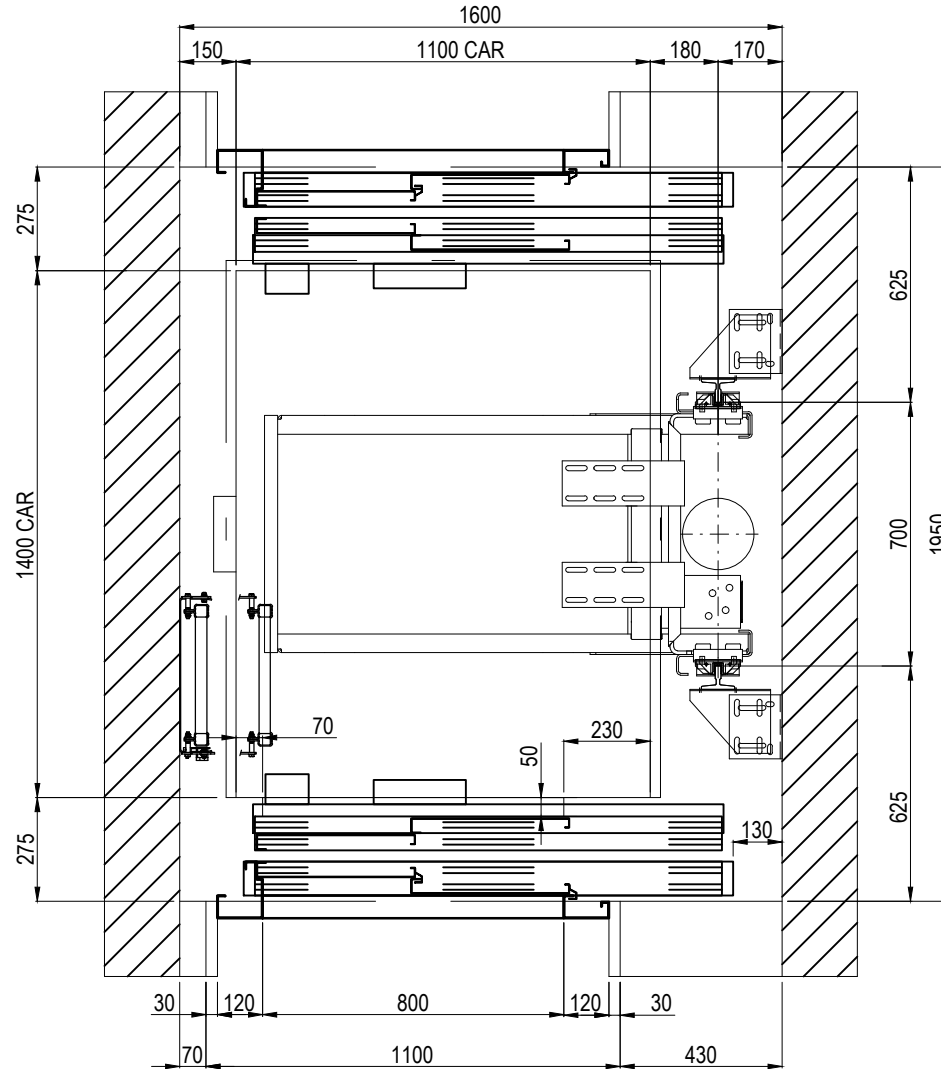

Waiver:

This data sheet is for guidance only and must not be used for proper working drawings. Please contact Stannah Lifts for particular details before proceeding. Owing to our policy of continual improvement we reserve the right to alter specifications and dimensions without prior notice

APPROVED 19/02/15

Stannah Lifts Ltd.
Anton Mill, Andover, Hampshire. SP10 2NX
Tel: 01264 339090
www.stannahlifts.co.uk



An independent family business since 1867

Maxilift 2.0

8 Person (630kg)

2S 800 Doors Adjacent Car Hydraulic Machine Room

Stannah

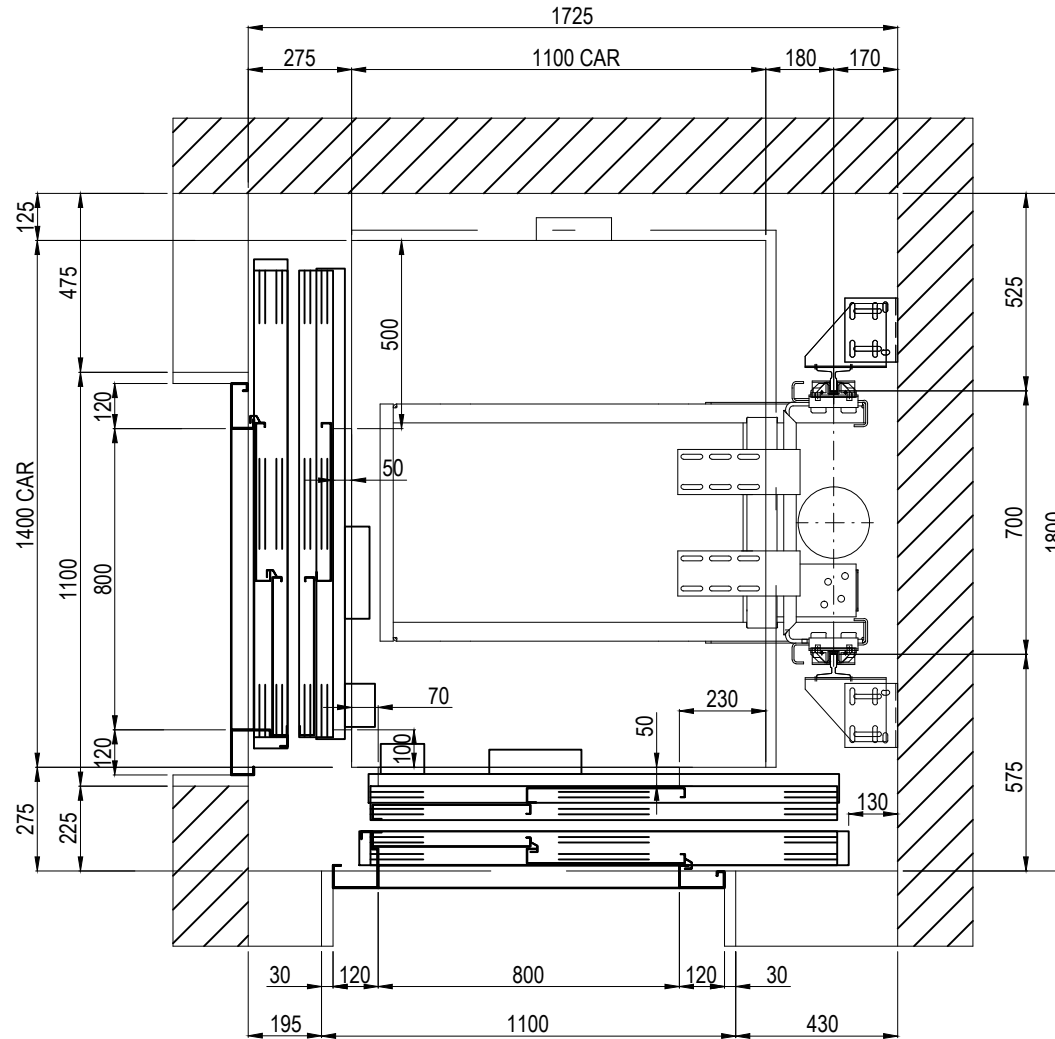

Waiver:

This data sheet is for guidance only and must not be used for proper working drawings. Please contact Stannah Lifts for particular details before proceeding. Owing to our policy of continual improvement we reserve the right to alter specifications and dimensions without prior notice

APPROVED 12/09/14

Stannah Lifts Ltd.
Anton Mill, Andover, Hampshire. SP10 2NX
Tel: 01264 339090
www.stannahlifts.co.uk



An independent family business since 1867

Maxilift 2.0

8 Person (630kg)

2S 900 Doors

Hydraulic Machine Room

Stannah

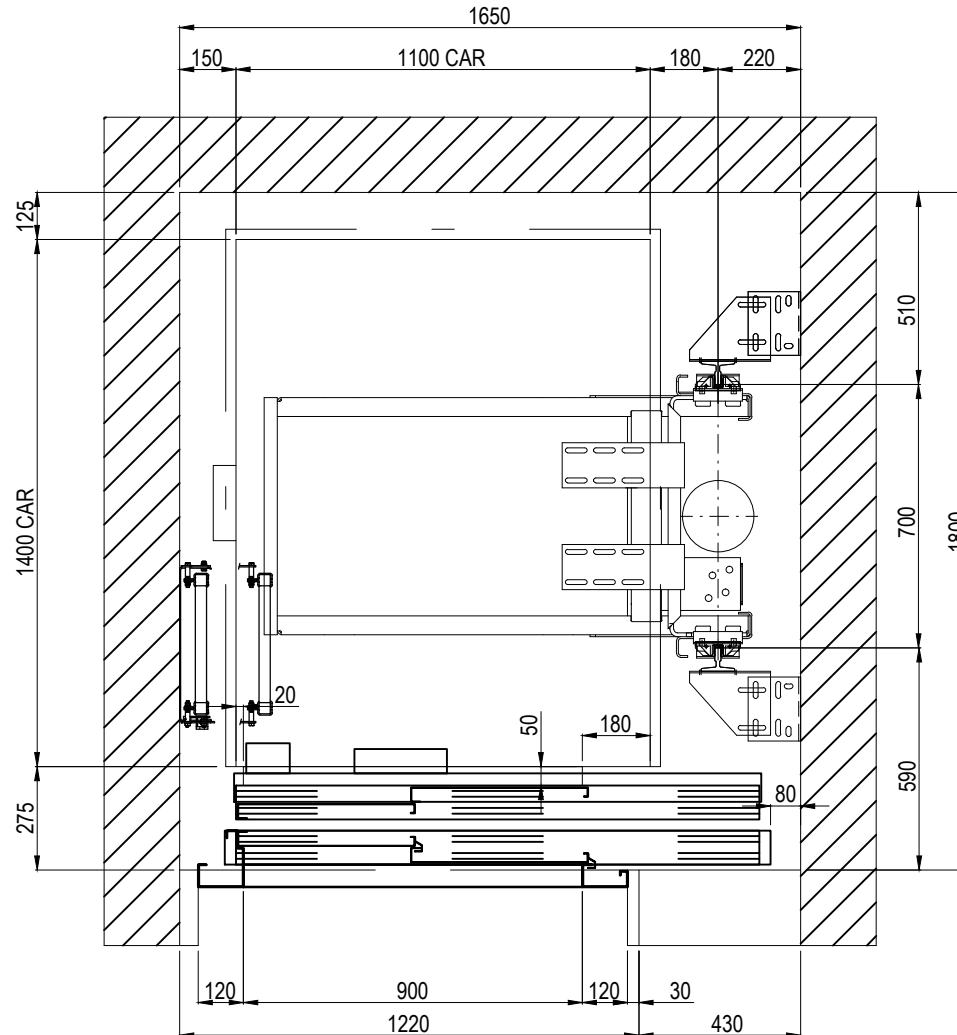

Waiver:

This data sheet is for guidance only and must not be used for proper working drawings. Please contact Stannah Lifts for particular details before proceeding. Owing to our policy of continual improvement we reserve the right to alter specifications and dimensions without prior notice

APPROVED 19/02/15

Stannah Lifts Ltd.
Anton Mill, Andover, Hampshire. SP10 2NX
Tel: 01264 339090
www.stannahlifts.co.uk



An independent family business since 1867

Maxilift 2.0

8 Person (630kg)

2S 900 Doors Through Car Hydraulic Machine Room

Stannah

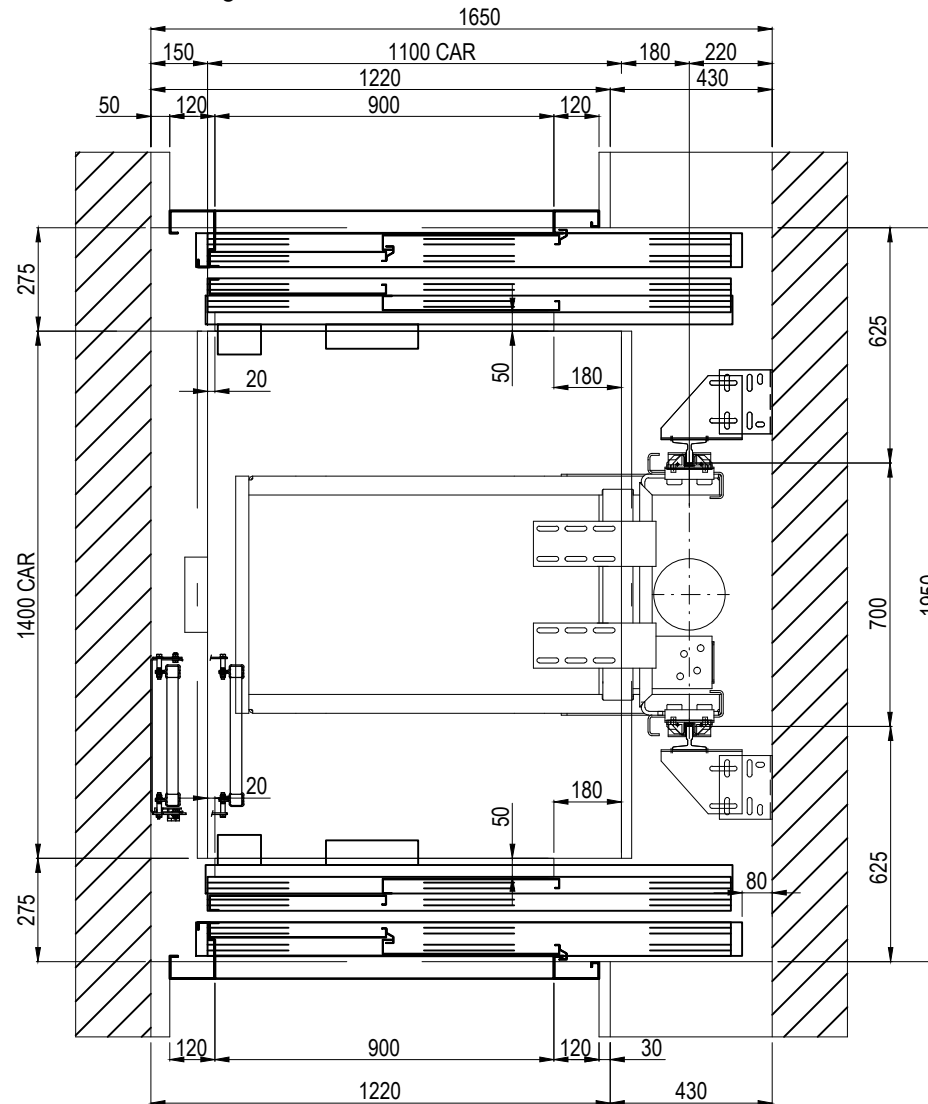

Waiver:

This data sheet is for guidance only and must not be used for proper working drawings. Please contact Stannah Lifts for particular details before proceeding. Owing to our policy of continual improvement we reserve the right to alter specifications and dimensions without prior notice

APPROVED 19/02/15

Stannah Lifts Ltd.
Anton Mill, Andover, Hampshire. SP10 2NX
Tel: 01264 339090
www.stannahlifts.co.uk



An independent family business since 1867

Maxilift 2.0

8 Person (630kg)

2S 900 Doors Adjacent Car Hydraulic Machine Room

Stannah

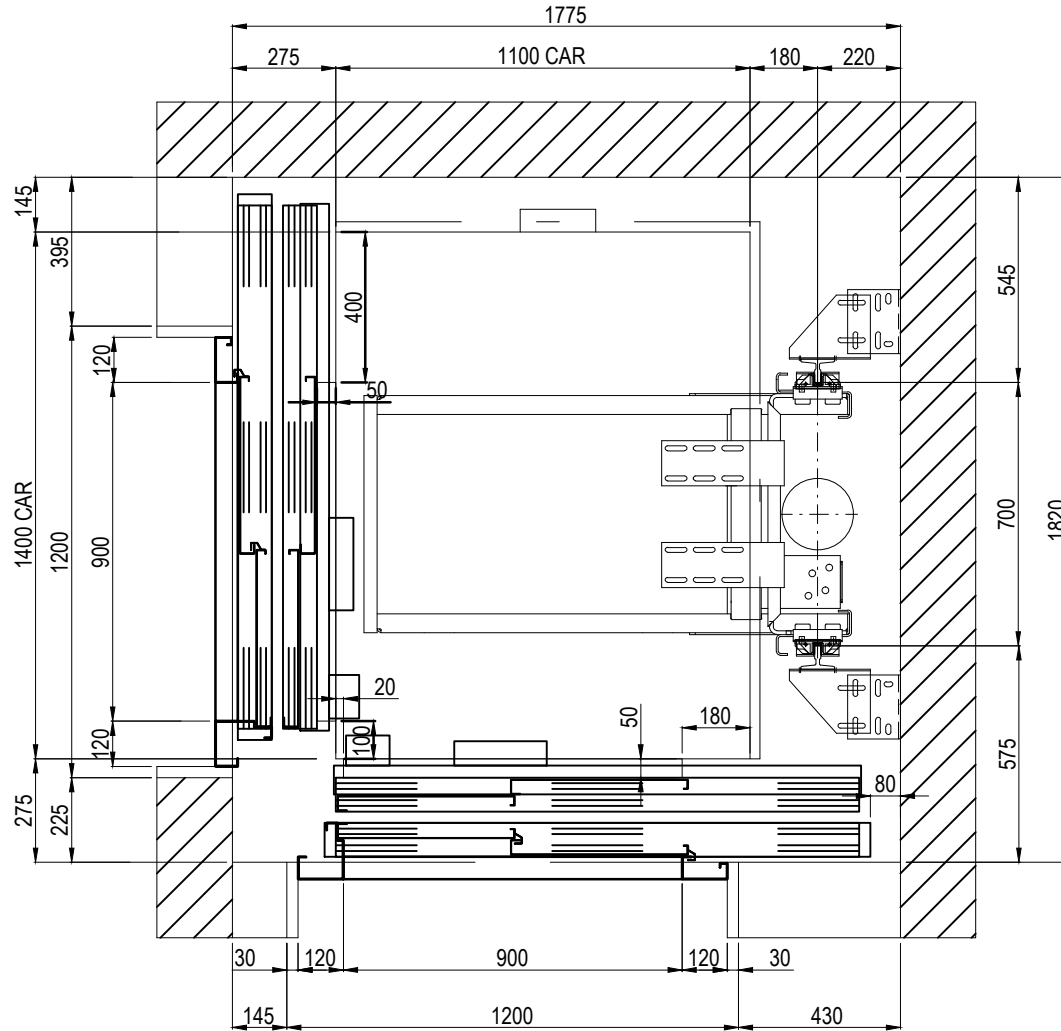

Waiver:

This data sheet is for guidance only and must not be used for proper working drawings. Please contact Stannah Lifts for particular details before proceeding. Owing to our policy of continual improvement we reserve the right to alter specifications and dimensions without prior notice

APPROVED 12/09/14

Stannah Lifts Ltd.
Anton Mill, Andover, Hampshire. SP10 2NX
Tel: 01264 339090
www.stannahlifts.co.uk



An independent family business since 1867

Maxilift 2.0

8 Person (630kg)

2C 800 Doors

Hydraulic Machine Room

Stannah

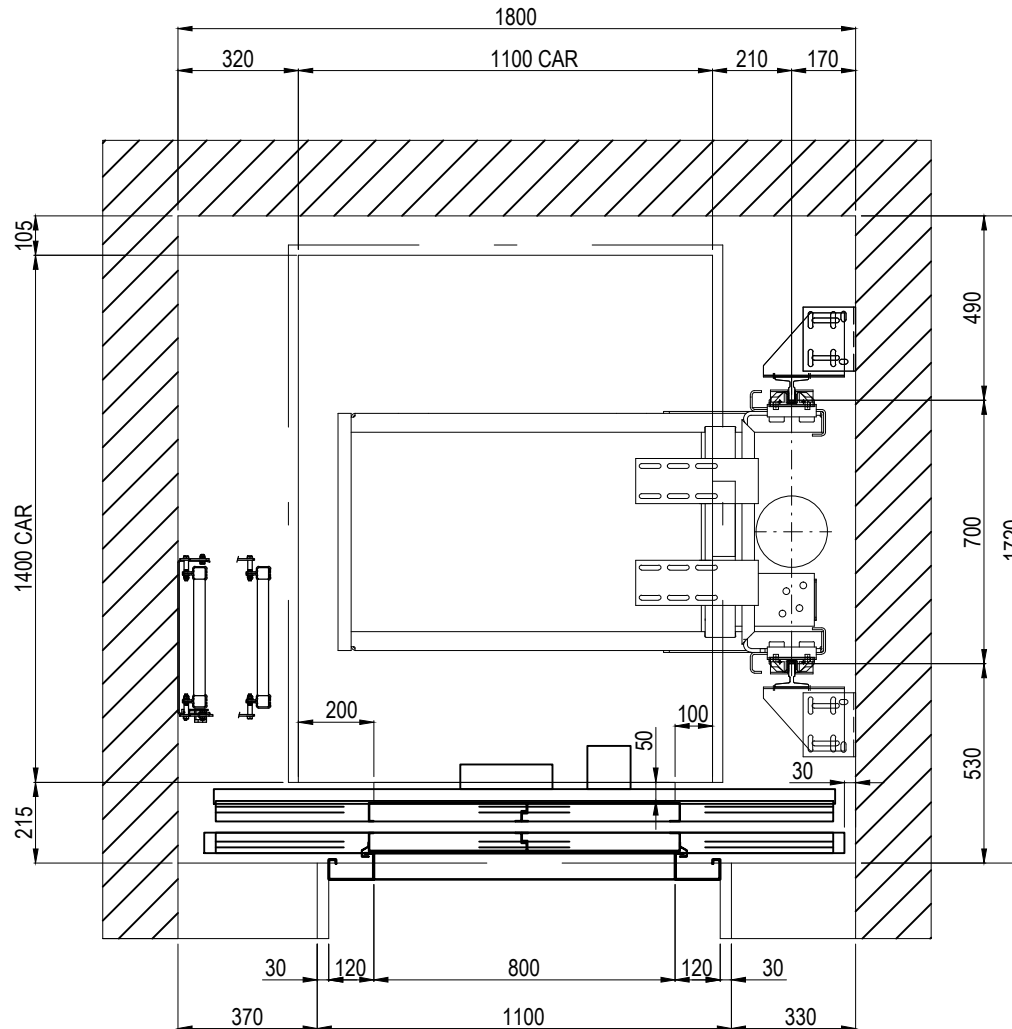

Waiver:

This data sheet is for guidance only and must not be used for proper working drawings. Please contact Stannah Lifts for particular details before proceeding. Owing to our policy of continual improvement we reserve the right to alter specifications and dimensions without prior notice

APPROVED 19/02/15

Stannah Lifts Ltd.
Anton Mill, Andover, Hampshire. SP10 2NX
Tel: 01264 339090
www.stannahlifts.co.uk



An independent family business since 1867

8 Person (630kg) 2C 800 Doors Through Car Hydraulic Machine Room

Stannah

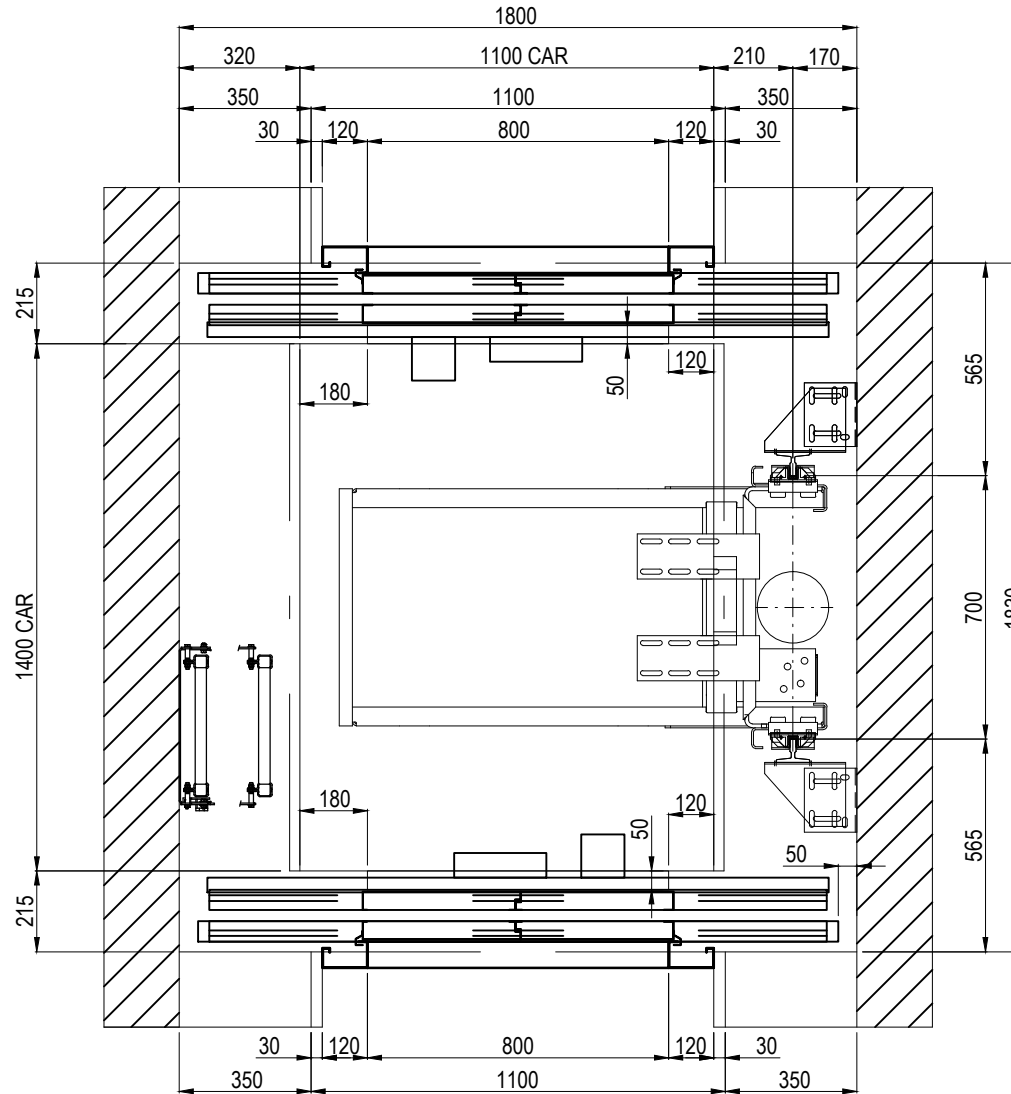

Waiver:

This data sheet is for guidance only and must not be used for proper working drawings. Please contact Stannah Lifts for particular details before proceeding. Owing to our policy of continual improvement we reserve the right to alter specifications and dimensions without prior notice

APPROVED 19/02/15

Stannah Lifts Ltd.
Anton Mill, Andover, Hampshire. SP10 2NX
Tel: 01264 339090
www.stannahlifts.co.uk



An independent family business since 1867

Maxilift 2.0

8 Person (630kg)

2C 900 Doors

Hydraulic Machine Room

Stannah

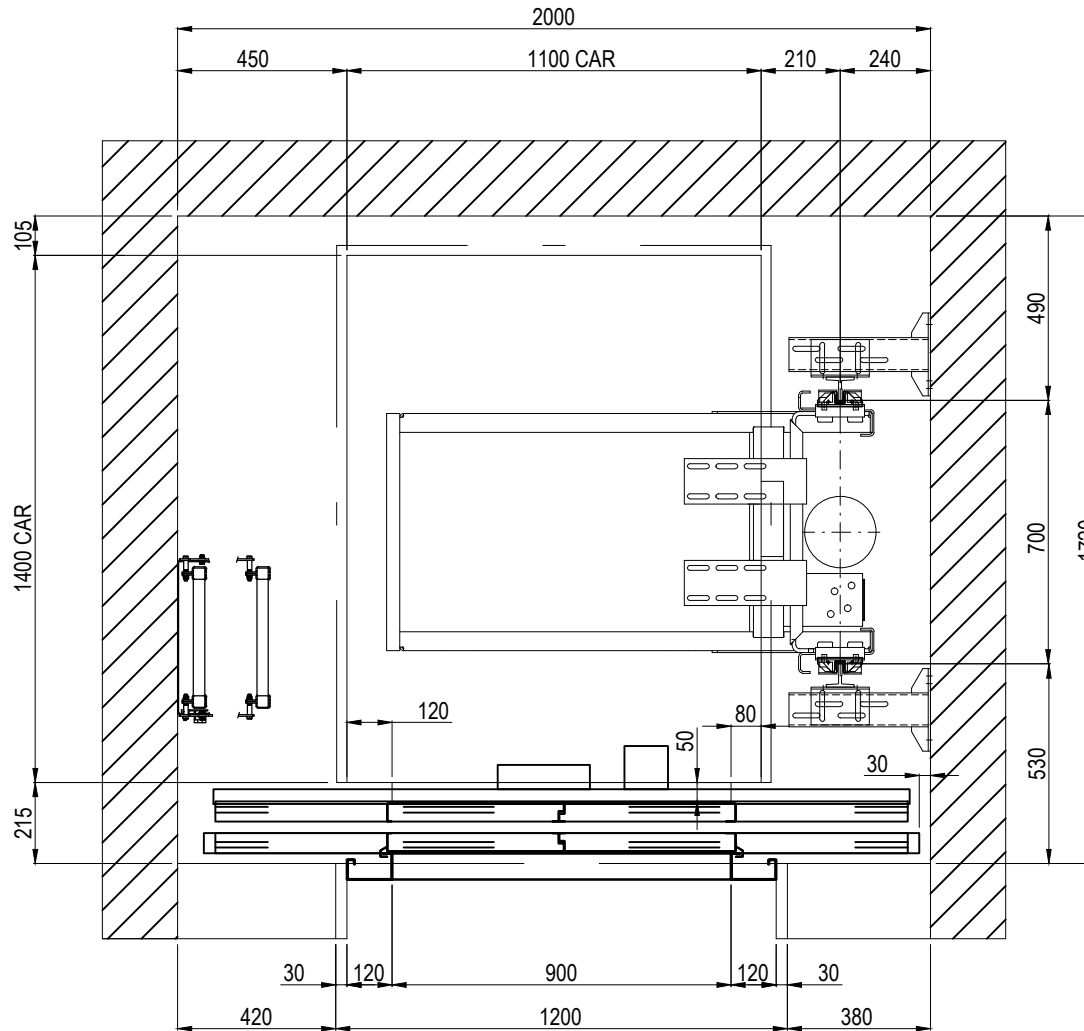

Waiver:

This data sheet is for guidance only and must not be used for proper working drawings. Please contact Stannah Lifts for particular details before proceeding. Owing to our policy of continual improvement we reserve the right to alter specifications and dimensions without prior notice

APPROVED 19/02/15

Stannah Lifts Ltd.
Anton Mill, Andover, Hampshire. SP10 2NX
Tel: 01264 339090
www.stannahlifts.co.uk



An independent family business since 1867

Maxilift 2.0

8 Person (630kg)

2C 900 Doors Through Car Hydraulic Machine Room

Stannah

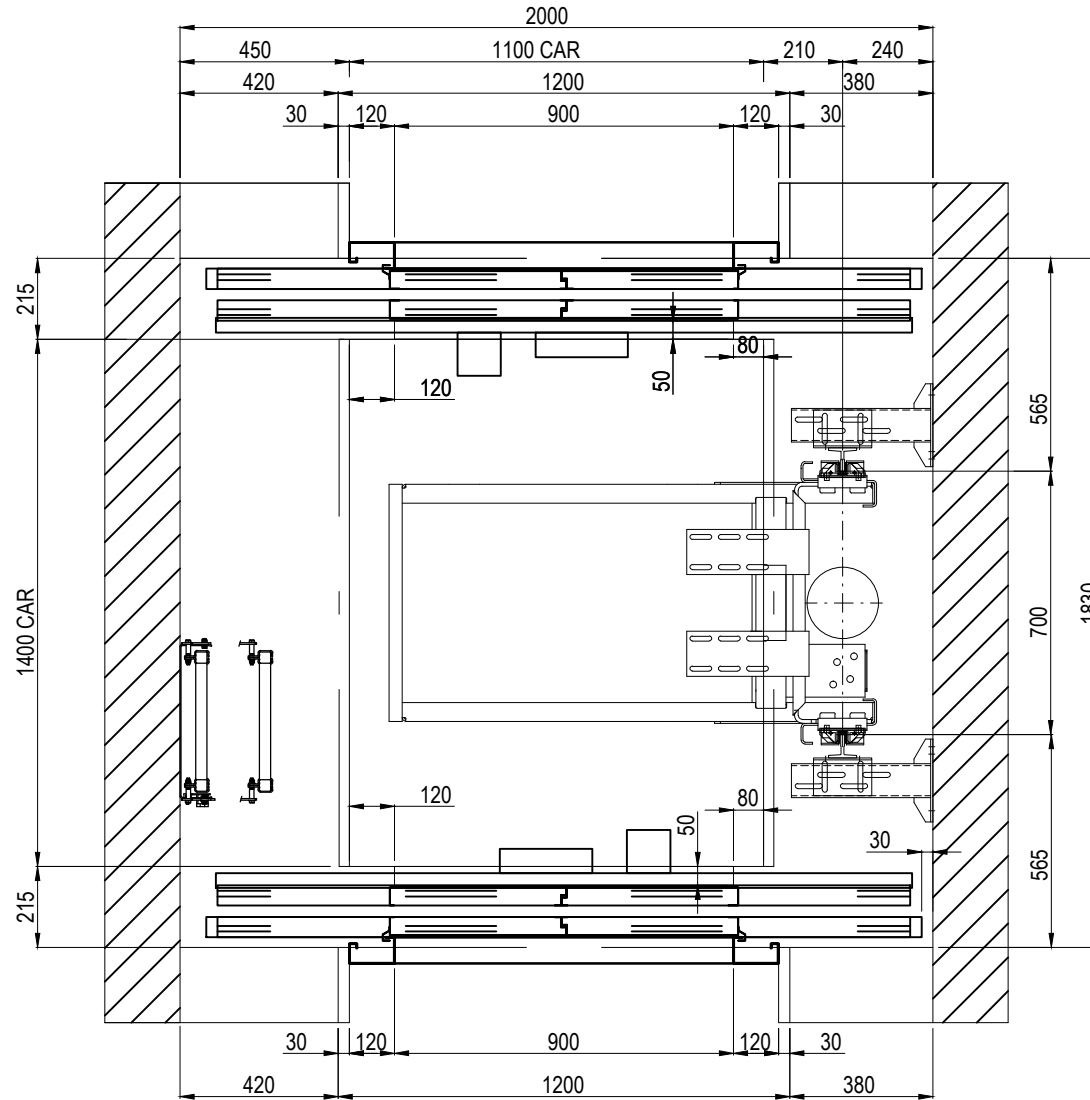

Waiver:

This data sheet is for guidance only and must not be used for proper working drawings. Please contact Stannah Lifts for particular details before proceeding. Owing to our policy of continual improvement we reserve the right to alter specifications and dimensions without prior notice

APPROVED 19/02/15

Stannah Lifts Ltd.
Anton Mill, Andover, Hampshire. SP10 2NX
Tel: 01264 339090
www.stannahlifts.co.uk



An independent family business since 1867

Maxilift 2.0

8 Person (630kg) Structure Supported

2S 800 Doors

Hydraulic Machine Room

Stannah

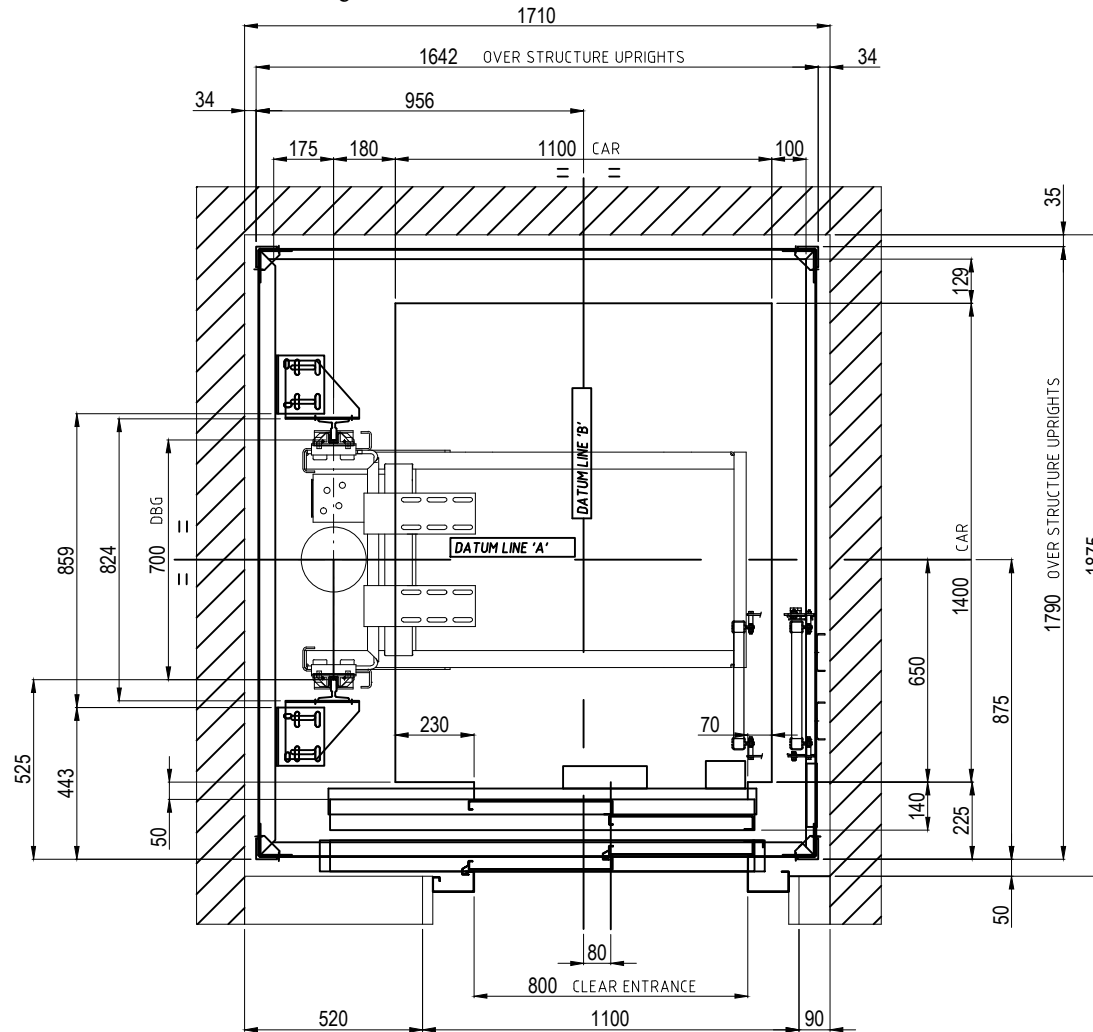

Waiver:

This data sheet is for guidance only and must not be used for proper working drawings. Please contact Stannah Lifts for particular details before proceeding. Owing to our policy of continual improvement we reserve the right to alter specifications and dimensions without prior notice

APPROVED 19/02/15

Stannah Lifts Ltd.
Anton Mill, Andover, Hampshire. SP10 2NX
Tel: 01264 339090
www.stannahlifts.co.uk



An independent family business since 1867

Stannah

Maxilift 2.0

8 Person (630kg) Structure Supported 2S 800 Doors Through Car Hydraulic Machine Room

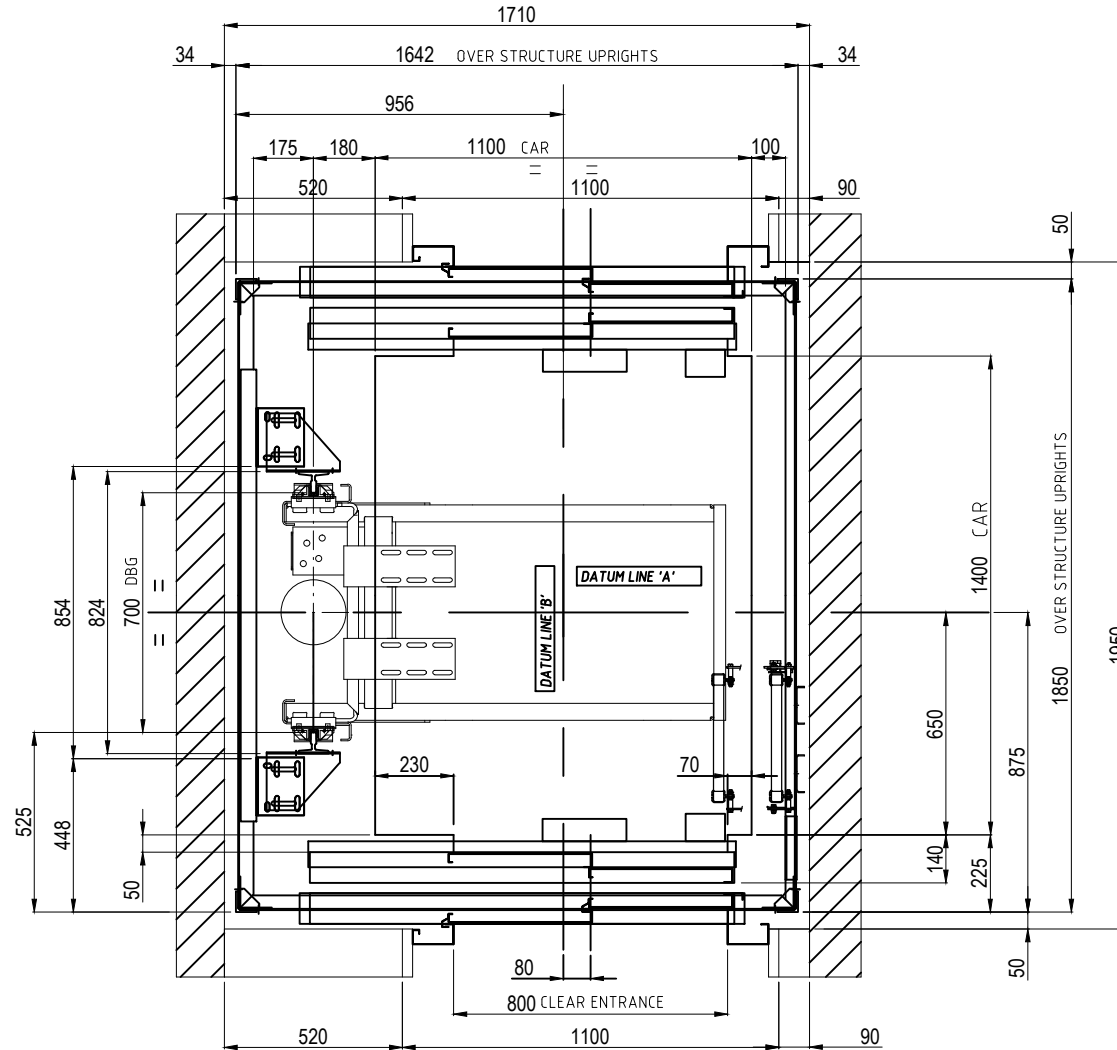

Waiver:

This data sheet is for guidance only and must not be used for proper working drawings. Please contact Stannah Lifts for particular details before proceeding. Owing to our policy of continual improvement we reserve the right to alter specifications and dimensions without prior notice

APPROVED 19/02/15

Stannah Lifts Ltd.
Anton Mill, Andover, Hampshire. SP10 2NX
Tel: 01264 339090
www.stannahlifts.co.uk



An independent family business since 1867

Stannah

Maxilift 2.0

8 Person (630kg) Structure Supported

2S 900 Doors

Hydraulic Machine Room

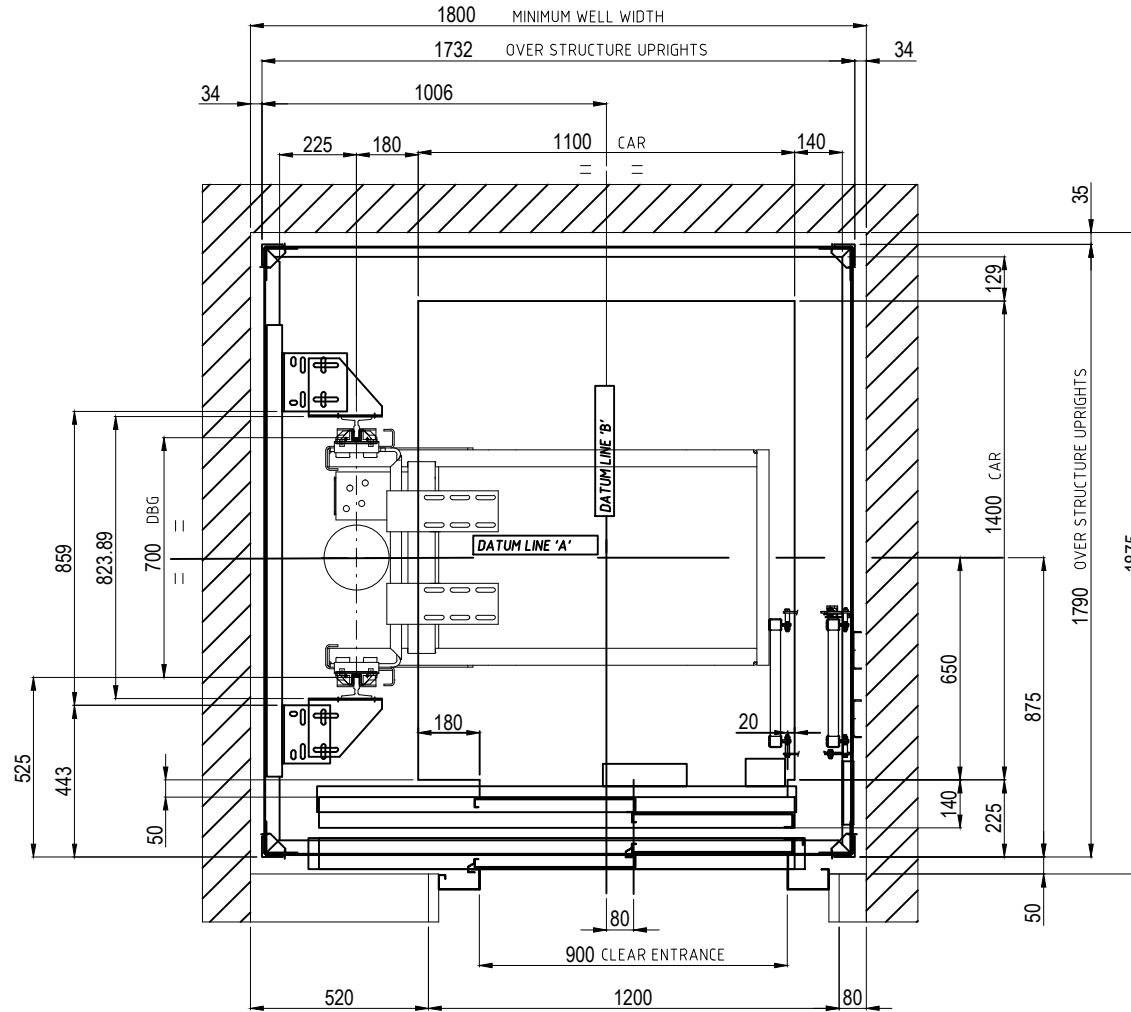

Waiver:

This data sheet is for guidance only and must not be used for proper working drawings. Please contact Stannah Lifts for particular details before proceeding. Owing to our policy of continual improvement we reserve the right to alter specifications and dimensions without prior notice

APPROVED 19/02/15

Stannah Lifts Ltd.
Anton Mill, Andover, Hampshire. SP10 2NX
Tel: 01264 339090
www.stannahlifts.co.uk



An independent family business since 1867

Maxilift 2.0

8 Person (630kg) Structure Supported
2S 900 Doors Through Car
Hydraulic Machine Room

Stannah

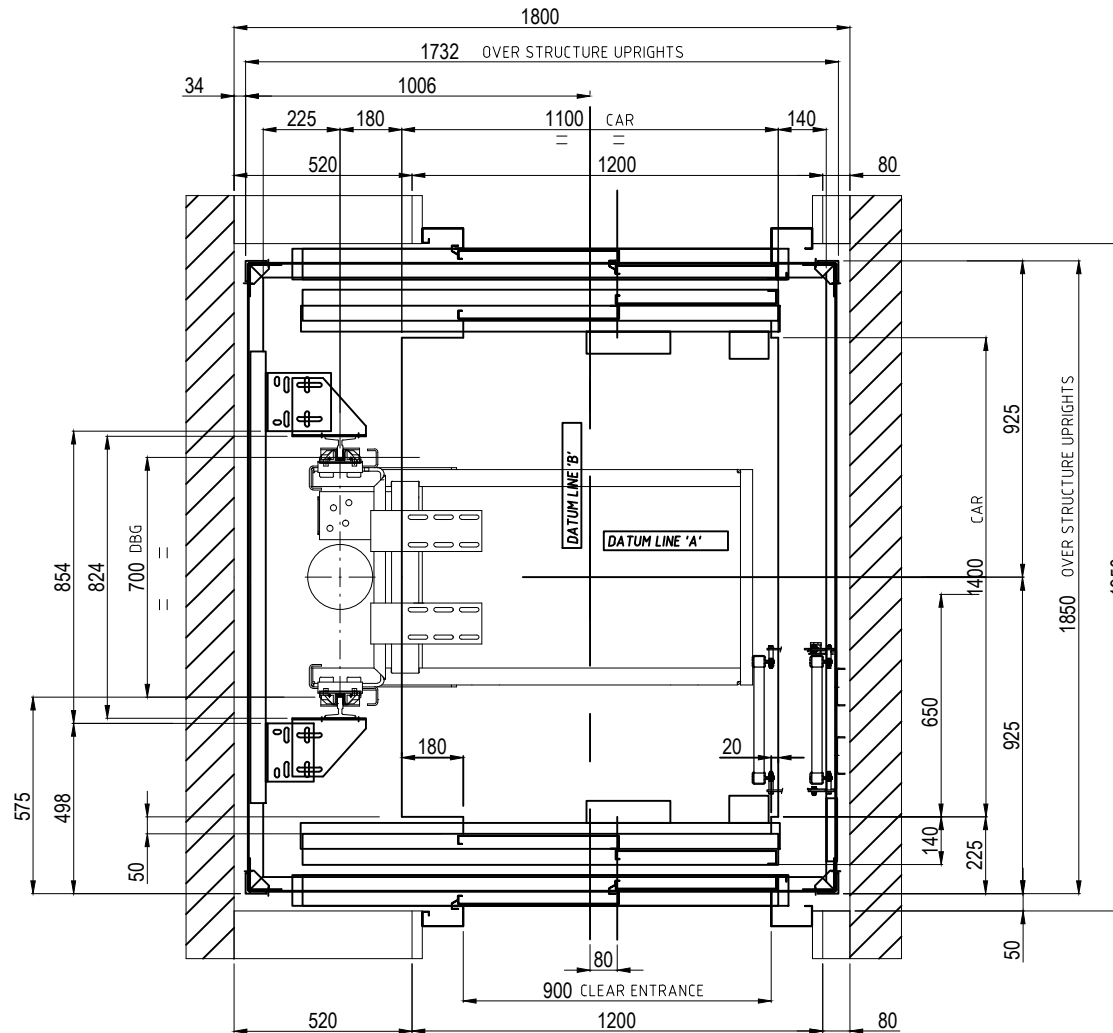

Waiver:

This data sheet is for guidance only and must not be used for proper working drawings. Please contact Stannah Lifts for particular details before proceeding. Owing to our policy of continual improvement we reserve the right to alter specifications and dimensions without prior notice

APPROVED 19/02/15

Stannah Lifts Ltd.
Anton Mill, Andover, Hampshire. SP10 2NX
Tel: 01264 339090
www.stannahlifts.co.uk



An independent family business since 1867

Stannah

Maxilift 2.0

8 Person (630kg) Structure Supported

2C 800 Doors

Hydraulic Machine Room

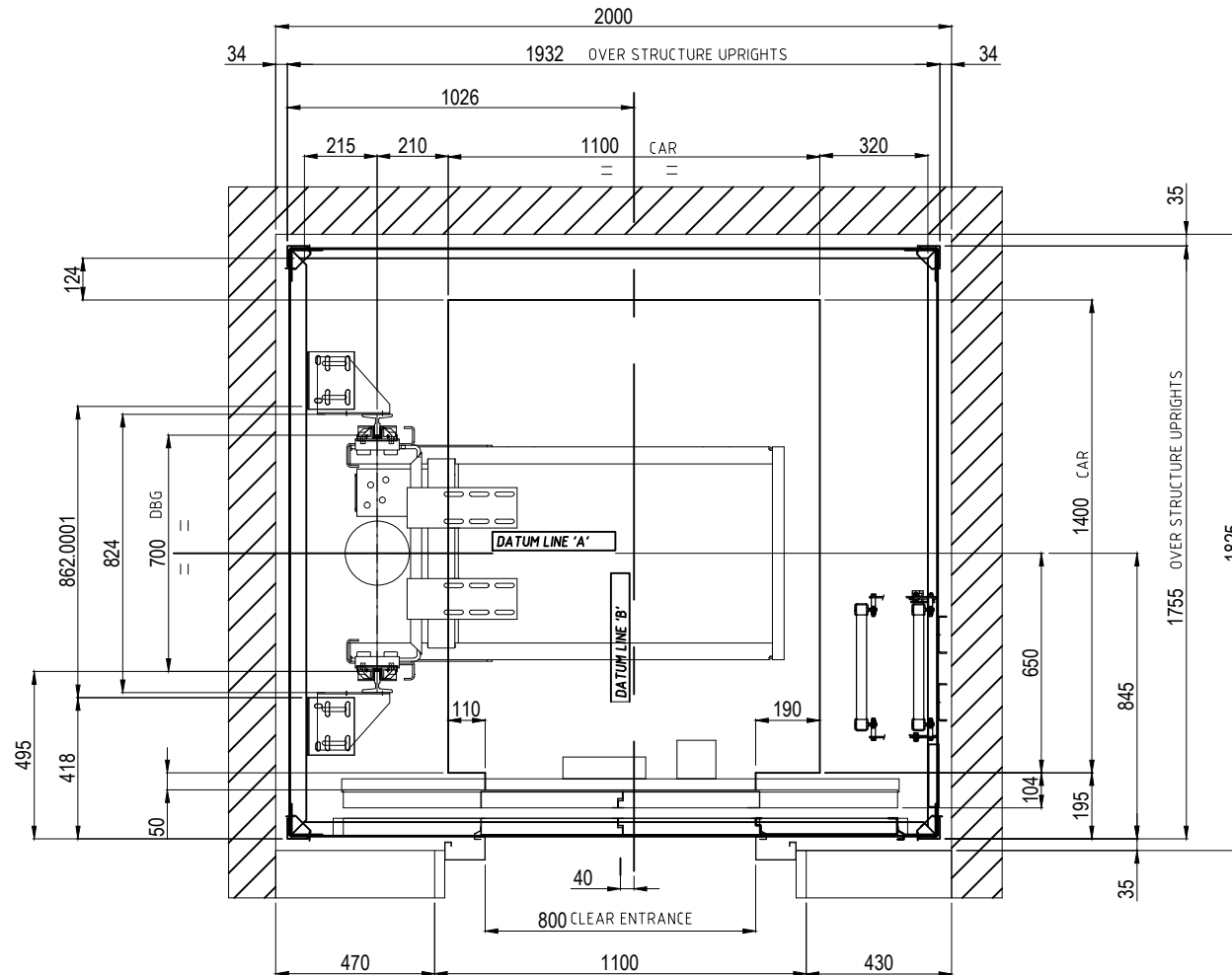

Waiver:

This data sheet is for guidance only and must not be used for proper working drawings. Please contact Stannah Lifts for particular details before proceeding. Owing to our policy of continual improvement we reserve the right to alter specifications and dimensions without prior notice

APPROVED 19/02/15

Stannah Lifts Ltd.
Anton Mill, Andover, Hampshire. SP10 2NX
Tel: 01264 339090
www.stannahlifts.co.uk



An independent family business since 1867

Stannah

Maxilift 2.0

8 Person (630kg) Structure Supported 2C 800 Doors Through Car Hydraulic Machine Room

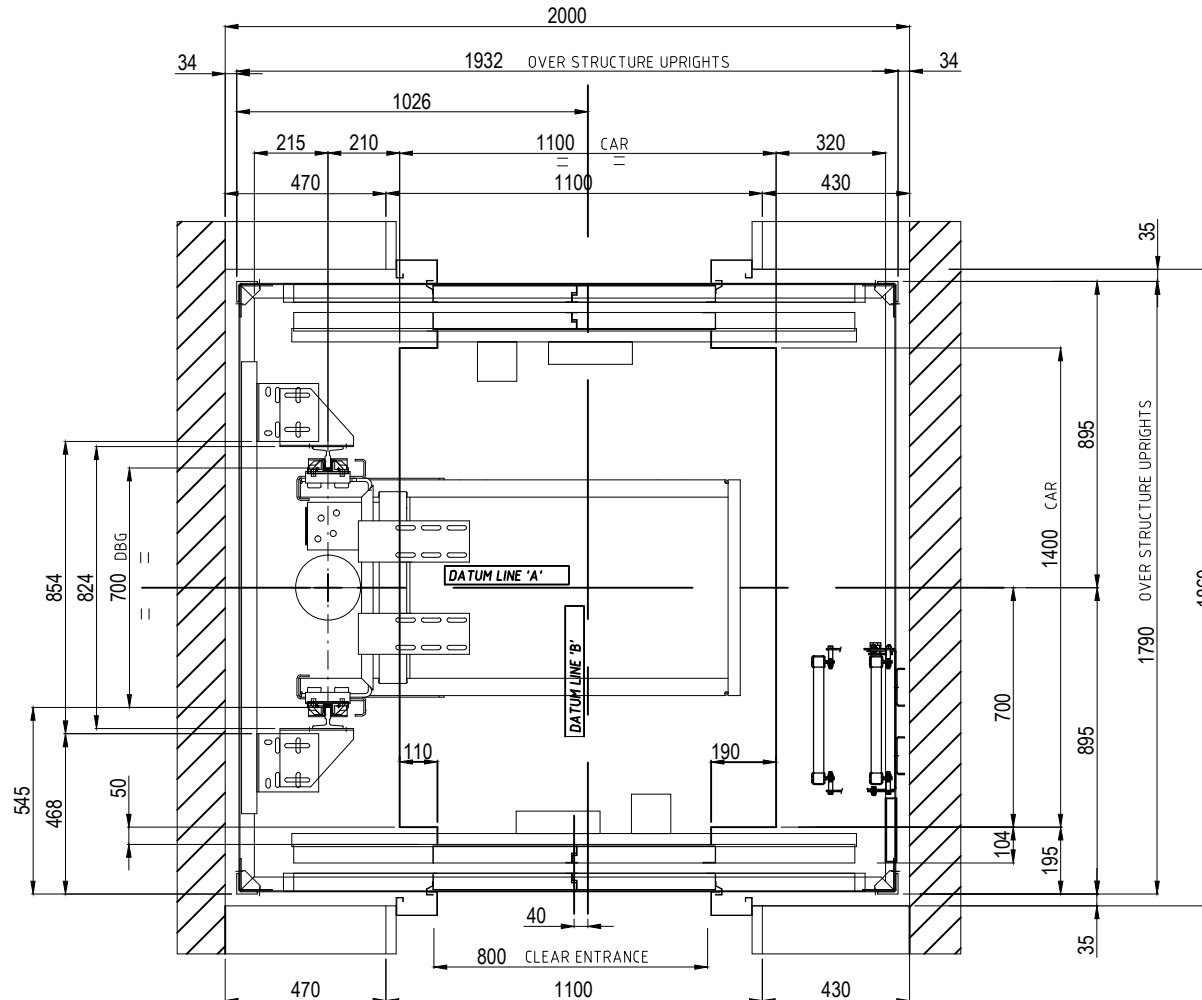

Waiver:

This data sheet is for guidance only and must not be used for proper working drawings. Please contact Stannah Lifts for particular details before proceeding. Owing to our policy of continual improvement we reserve the right to alter specifications and dimensions without prior notice

Stannah Lifts Ltd.
 Anton Mill, Andover, Hampshire. SP10 2NX
 Tel: 01264 339090
www.stannahlifts.co.uk